

The Lakhovsky MWO: Back To Square One

Peter A. Lindemann

Sometimes the most obvious things take the longest. I am reminded of all the wild hype that surrounded Tesla's work back in the 1980's and the crazy new theories that were put forth on how his wireless power system supposedly operated. Smelling a rubber fish in the pan, BSRF railed against the madness and eventually released a video presentation of Tesla's wireless power system in action. Remarkably, all it took was the genius of Eric Dollard and *going back to Tesla's patent*. The model built from the patent performed as claimed. No new theories or explanations were needed. This video, **Tesla's Longitudinal Electricity** is proof enough that going back to the original design is the best place to start when trying to understand or *duplicate* someone's work.

So, the question is, has anyone ever tried to *duplicate* Lakhovsky's MWO as it is described in his patent? After finally asking myself the right question, I carefully read through **The Lakhovsky Multiple Wave Oscillator Handbook** for the answer. What I found is quite interesting. Every single MWO schematic printed in the book, except for Lakhovsky's patent diagram, is a model of or a variation on one of Tesla's electro-therapeutic devices! It seems that for the last 30 years, people have just been putting Lakhovsky's famous multi-ringed antenna at the end of a Tesla circuit and thinking that they had the real thing. All of these units, variations on a circuit presented by Bob Beck in 1963, spark profusely between the rings of the antenna. Bob has repeatedly told experimenters to build their MWOs with more and more power so that they will produce increasing amounts of sparking on the antenna. Our files contain letters from people who report excellent results from these devices. The accolades, however, have not been universal. The big problem with this style of MWO is that people who are sensitive to subtle energy, like myself, can't stand to be in the same room with one of them while they are operating because they are so irritating. Something was not right in all of this, and I wanted to figure it out.

To illustrate the problem, I have included four schematic diagrams here for reference. Figure 1 is the schematic of Lakhovsky's MWO taken from his patent. Figure 2 is a schematic taken from an article by Tesla on his electro-therapeutic experiments. Figure 3 is the schematic for a "high power MWO" taken from page 77 of the **MWO Handbook**, and

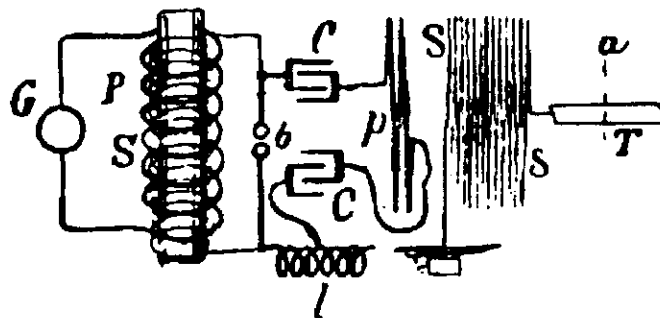

Figure 2

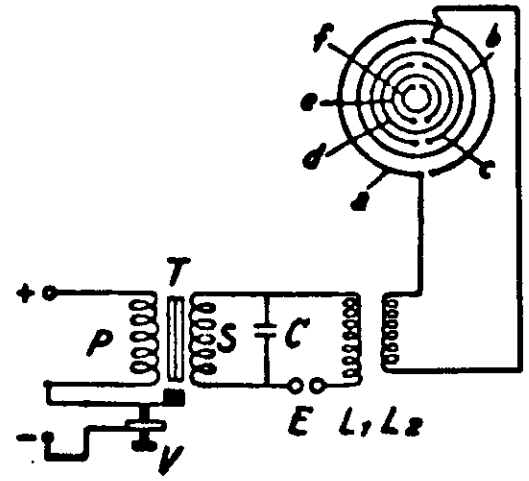

Figure 1

Figure 4 is the schematic of the Bob Beck/Klark Kent MWO (simplified). After studying these circuits for a while, I realized that there were a number of basic differences. Lakhovsky had placed the spark-gap and the capacitor in a different relationship in the middle section of the circuit than Tesla and the others. Could this be important? Lakhovsky had also stepped the voltage down in the final stage of the circuit where Tesla and the others all stepped the voltage way up. Was this significant? What was Lakhovsky trying to do that was different than what Tesla was trying to do?

There were some other things that also puzzled me. Both Lakhovsky and Tesla had well developed subtle sensitivities. Lakhovsky used a pendulum to help him in his design work and Tesla's expanded sensory abilities are mentioned throughout his writings and the writings of his biographers. Because of this, I assume that both of their electro-therapeutic devices were totally benign to be near, even to very sensitive people, like themselves. I assume this because nothing leaves my laboratory that I don't personally like. Experiments I have run strongly suggest that all of the effects that cause sensitive people to be irritated by these units (Beck/Kent style MWO) come from the sparking between the rings of the antenna. This brings up the question of whether or not the MWO antenna is supposed to spark. Tesla is very clear in his writing that his units worked much better when all electrical discharges from the terminals were suppressed. At one point, he even describes using 2 inches of wax to cover the terminals (antennas). Likewise, Lakhovsky never mentions sparking discharges between the rings of his antennas. Some photos show a brush or corona discharge off the

outermost ring of his MWO antennas, but no mention is made of this being the normal therapeutic operating mode. Also, no photo of Lakhovsky's MWOs ever show arcing *between* the rings. In light of this, I am convinced that both Tesla and Lakhovsky designed their devices to eliminate this behavior. I strongly believe that Lakhovsky's real MWO does not create sparking discharges

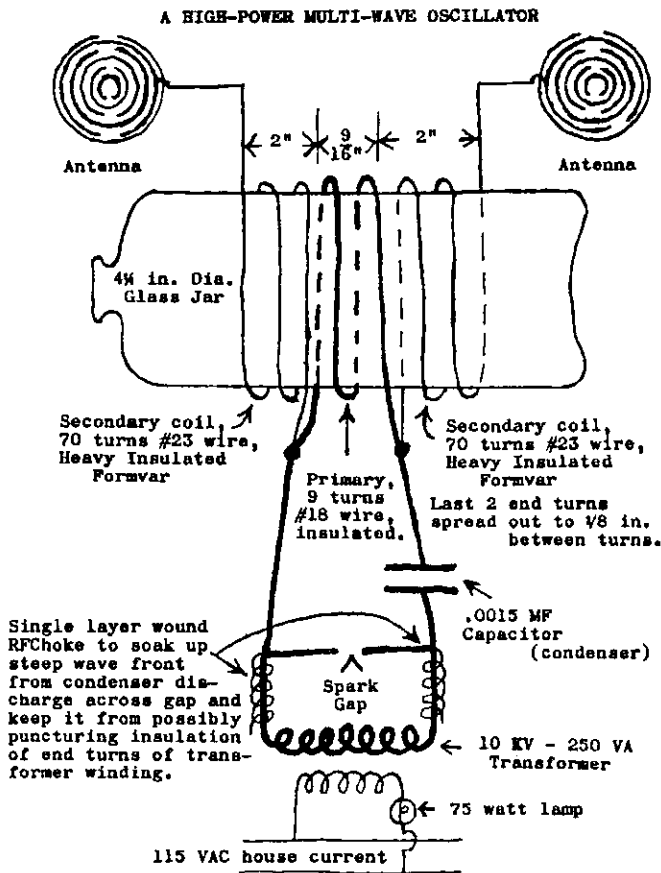

Figure 3

between the rings of the antenna.

Having resolved these issues to my own satisfaction, I decided that the only way to find out the rest of the facts was to actually build a circuit that behaved like the circuit in Lakhovsky's patent. To do this I had to decide what components to use, as no parts values are given in the patent. Even if they were, these parts would not be available today. What to do? In Figure 1, Lakhovsky begins by powering the primary coil of a transformer on DC (direct current) that is rapidly interrupted by a device he calls a "trembler" (V in Figure 1). The purpose and function of this trembler is to provide a sequence of DC pulses to the primary of the transformer by mechanically making and breaking the DC power feed to the primary winding. I decided that one of Klark Kent's 12 VDC power supplies driving the primary of an automobile ignition coil interrupted by a solid-state transistor circuit was a suitable modern substitute. It performed the same functions that Lakhovsky specifies in the patent. I 'acquired' one of Klark Kent's MWO units from the Borderland collection and went to work.

Besides the first stage power supply driving the primary of the coil, everything else in the Klark Kent MWO was essentially a Tesla circuit, so I took it apart. I removed the high voltage output coil completely and rewired the capacitors and spark-gap so that they were in the right place in the circuit according to Lakhovsky. The L1 and L2 output coils I decided to build, since

no suitable replacements were available. Without any clear directions from the patent about the proper dimensions for these coils, I actually had to *think* about it. Small, tightly wound coils usually block high frequency signals and, for this reason, are sometimes called "chokes". Obviously, these coils were not supposed to be extremely small because passing a wide spectrum of high frequency currents was their purpose. By contrast, one of Tesla's designs specifies a 2 foot diameter coil set in this location in the output. But photos of Lakhovsky's MWOs clearly show no coils that large. I decided to wind two coils about 2 inches in diameter to begin my experiments. L1, the primary, I wound with 7 turns of bare #18 single strand copper wire. The turns are about 1/3 of an inch apart and stand free in the open air with no dielectric material or coil form near-by. L2, the secondary, is only 5 turns of similar wire and dimension. The two coils are placed end to end about an inch apart. The ends of L2 are connected to rings 1 and 2 of the printed circuit board MWO antenna developed by Eric Dollard and BSRF, as illustrated in Lakhovsky's patent. L1 is connected to the capacitor and the spark-gap.

Awesome! I was finally in possession of a reasonable facsimile of a *real* Lakhovsky MWO (Figure 5). [I decided to retain the high voltage diode from the Klark Kent circuit to help protect the ignition coil from the discharge of the capacitor. This was the only deviation from the Lakhovsky circuit that I made, and I do not believe it negatively affects the quality of the output since it is not in the capacitor discharge loop.] In trembling anticipation, (not really) I turned the unit on. Besides the irritating noise of the spark-gap, the energy effect coming from the antenna was very gentle and very penetrating. Within 15 minutes, a noticeable relaxation effect was evident and a gentle "buzz" feeling was present throughout my body. This experiment, long overdue, begins to confirm my many speculations about the nature of Lakhovsky's MWO and opens up a clear, new direction for future research.

The two design changes that this article addresses are: 1) the location of the spark-gap in the circuit and 2) the method of driving the antenna. In Tesla's circuits and the Bob Beck/Klark Kent style of MWOs, the spark-gap is driven by the *inductive collapse* of the secondary coil and the output primary coil is capacitively coupled to this source of oscillations. In Lakhovsky's circuit, the inductive collapse of the secondary coil charges the capacitor and the *capacitor discharge* drives the spark-gap directly through the primary of the output coil. This difference has never been discussed before and I believe it to be important. A

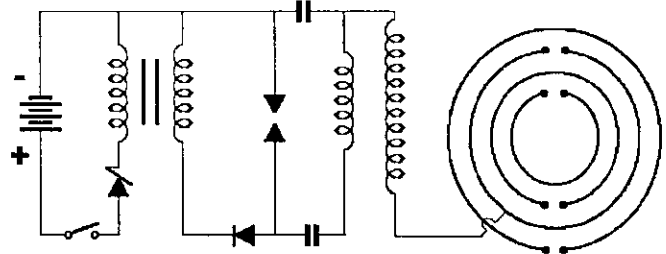

Figure 4

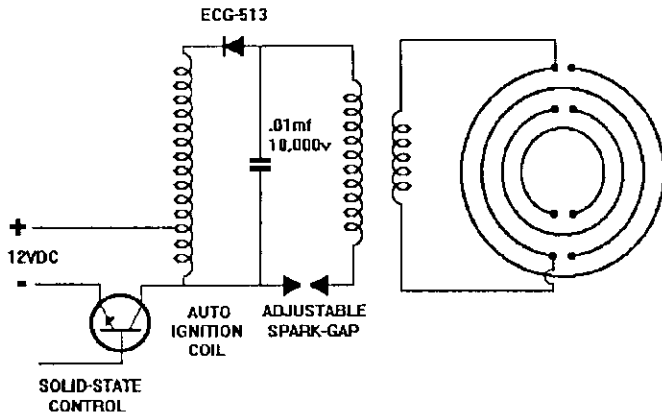

Figure 5

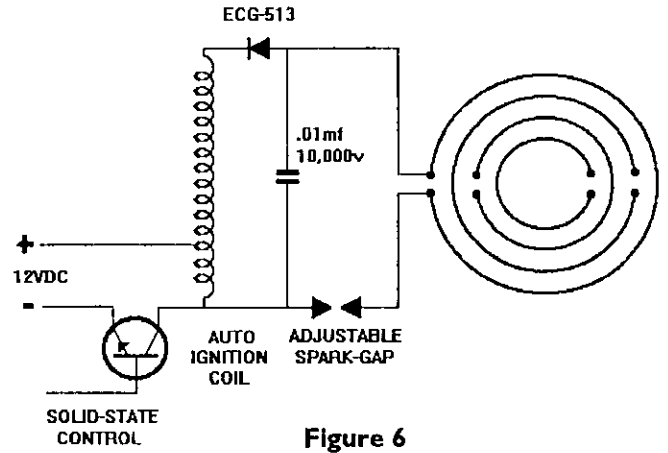

Figure 6

capacitor discharge creates a very different kind of "spark" than an inductive collapse. (Anyone not understanding this should watch the first 20 minutes of the BSRF video **Free Energy Research**. In it, Eric Dollard demonstrates both inductive and capacitive arcs and discusses the differences between them.) The Beck/Kent style of MWO uses the circuit primarily as a source of high voltage to produce arcing between the rings of the antenna. The various lengths of sparks at the antenna become the source of the wide spectrum of frequencies produced by the device. While this method may produce the required wide band of emissions, it was not the method Lakhovsky was working on. The patent is clear on this point, Lakhovsky envisioned the capacitor discharge as the source of his wide spectrum of frequencies and the multi-ringed antenna as a resonator system to draw out even more and higher harmonics by induction. As usual, the simple creation of multiple frequencies is not enough. The subtle nature of these frequencies and how they are created is also important.

Many experiments need to be tried on all of the possible methods of driving the antenna that are covered by the patent. Beyond that, the patent describes using only one antenna, whereas all of the photos of Lakhovsky's MWOs show him using two antennas. The exact antenna hook-up is still unknown. I have now driven the antenna both electro-statically, as specified in the patent (Figure 5), and electro-magnetically by eliminating

L1 & L2 and directly connecting the outer ring of the antenna in the place of L1 (Figure 6). The effects subjectively seem stronger in the direct connection mode, but both are gentle and penetrating. I have also driven two phi-ratio spiral antennas in the electro-static mode facing each other, each spiral connected at its center to one end of L2 (Figure 7). The effects in the space between the two antennas are the most powerful I have seen yet. While use of these golden section spirals is a deviation from Lakhovsky's designs, the configuration of using two antennas to set up an area of high frequency electrostatic oscillations between them was his intent, it seems. The effect in the area between the antennas is quite strong and lends credence to the electro-static mode of operation. Tesla also experimented with this method of driving the antennas which he called terminals (t) as shown in Figure 8. He used large copper plates for these terminals, and as such, did not expect them to augment the total frequency response of the system as Lakhovsky did with his multi-ringed antennas. My experiments suggest that when using one antenna, the electro-magnetic hook-up is the strongest, as in Lakhovsky's RCO circuits. When using two antennas, the electro-static hook-up is the strongest, as in Lakhovsky's MWO circuits.

In future articles, I plan to address the construction of a real Lakhovsky MWO antenna made from copper tubes suspended on silk threads as specified in the patent. I believe that the copper rings, unencumbered by the proximity of any dielectric material, will be able to 'ring' freely up into the very high harmonics Lakhovsky envisioned. This could be the final 'improvement' necessary to get us all the way back to where Lakhovsky was in 1931. The design for the real MWO may have been with us all along. Sometimes the most obvious things take the longest.

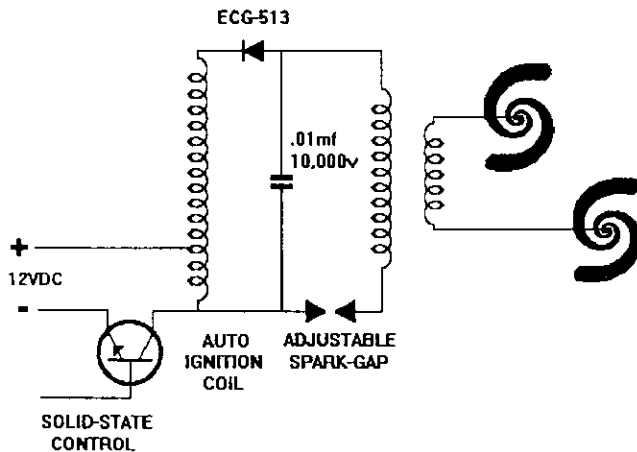

Figure 7

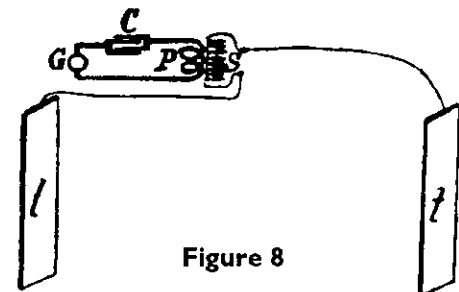

Figure 8